



Universal camera holder for sugarcube cameras

Datasheet

9/2024

atesystem 
FOCUSED ON **DETAIL**

ATEsystem s.r.o.
Technologická 375/3
708 00 Ostrava-Pustkovec
Czech Republic

T +420 595 172 720
E atesystem@atesystem.cz
W www.atesystem.cz

DOCUMENT INFORMATION

Revision number	Author	Revision date	Description
1	Pavlišťík Radek	19. 04. 2022	Initial release
2	Leoš Maršálek	25. 08. 2023	Updated formal information
3	Tomáš Moj	19.09. 2024	Update product description

Attachments

Notes

Contact

ATEsystem s.r.o.

Technologická 375/3

708 00 Ostrava–Pustkovec

Czech Republic

T +420 595 172 720

E produkty@atesystem.cz

W www.atesystem.cz

All rights reserved. No part of this document may be published, transported on any medium, copied or translated into foreign languages without previous written approval of ATEsystem s.r.o.

ATEsystem s.r.o. does not assume any guarantees for the content of this document and any incidental misprints.

Names of products and companies used in this document may be trademarks or registered trademarks of their respective owners.

ATEsystem s.r.o. © 2024

OBSAH

1 KEY FEATURES..... 4

2 PRODUCT DESCRIPTION 4

3 MOUNTING DRAWINGS 5

4 PRODUCT OPTIONS..... 6

1 KEY FEATURES

- Universal for many camera types.
 - Basler ace, Basler ace2, FLIR, IDSAVT-MAKRO, Opto-Engineering cameras - COE, LUCID, JAI GO.



Fig. 1 – Universal holder with mounted camera Basler ace2

2 PRODUCT DESCRIPTION

The camera holder consists of one aluminum part. Holder is equipped with two types of threads (M8, UNC20) for montage. The surface finish of all parts is black matt anodized, which increases scratch resistance.

Parameter	Value
Dimensions without mounting rod	53,6 x 39 x 51 mm
Mounting rod length x diameter	30 x 12 mm
Camera front dimensions	29 x 29 mm
Weight	107 g
Types of threads	M8, 1/4"

Tab. 1 – Heat sink parameters

Universal camera holder for sugarcube cameras is designed to be easily used with the standard Balluff fastening system. For this purpose, 12 mm diameter mounting rod is used, which fits perfectly into the fasteners (The rod for the camera holder is not part of the package, it can be purchased as an accessory under order number 62025004).

3 MOUNTING DRAWINGS

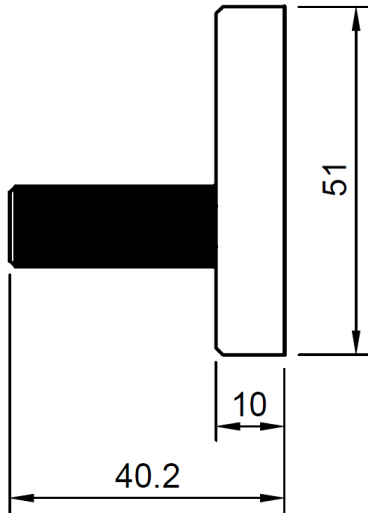

Side view:

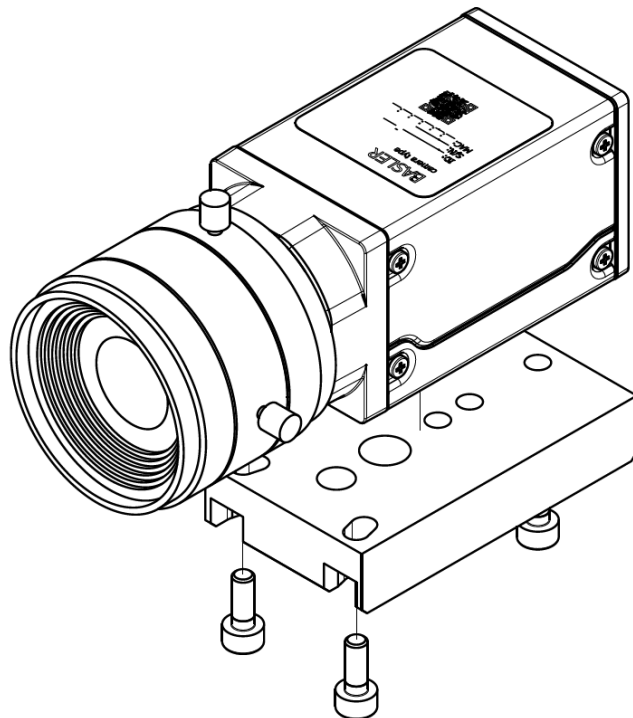
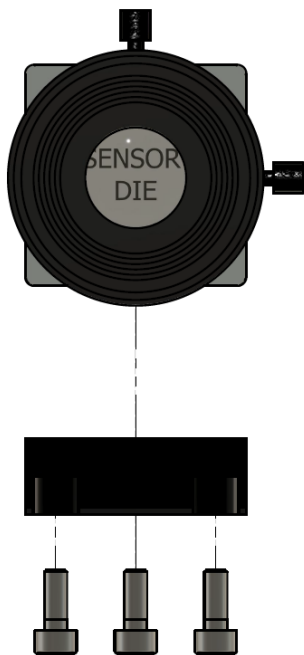
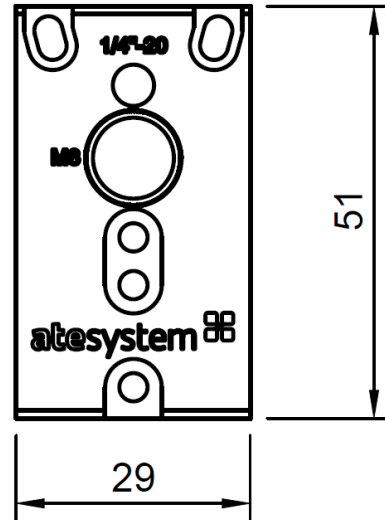

Bottom view:



4 PRODUCT OPTIONS

Order number	Description	
62025003	Universal camera heat sink Package: 2x side heatsink, 1x holder, 4x M4x10, 3x M3x8	
62025001	Universal camera holder Package: 1x holder, 3x M3x8	
62025004	Rod for holder M8 D12x40mm	

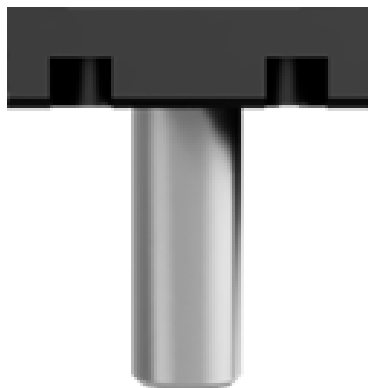

**Fig. 4 – Left: Front view of the holder without camera,
 Right: View of holder from below without camera**



Fig. 5 – Left: Holder with mounted camera ace USB3,
Right: Holder with mounted camera ace GigE



Fig. 6 – Left: Holder with mounted camera ace2 USB3,
Right: Holder with mounted camera ace2 GigE

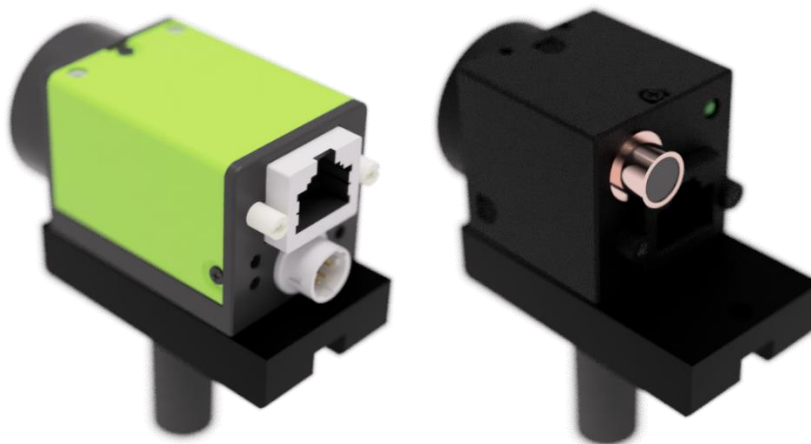

Fig. 7 – Left: Holder with mounted camera JAI,
Right: Holder with mounted camera FLIR